

86Duino Filament Color List

Update: 2018/01/10

mini系

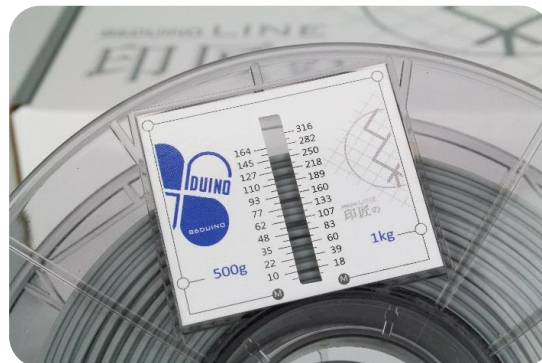

500g

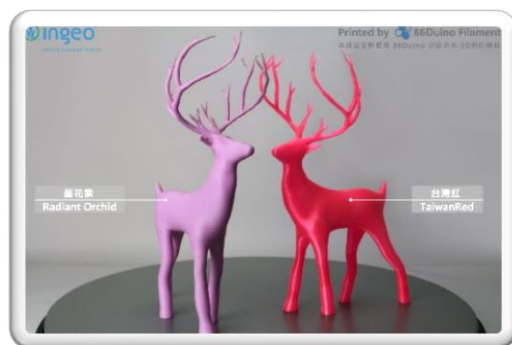
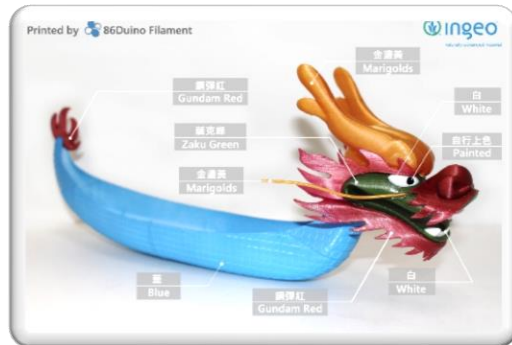
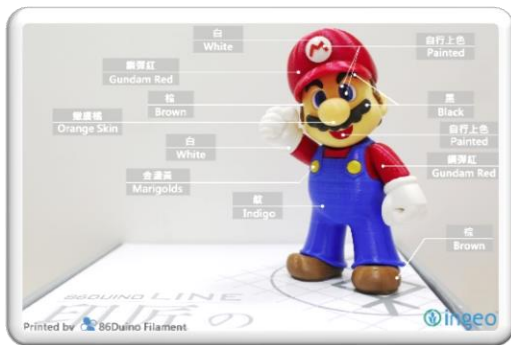
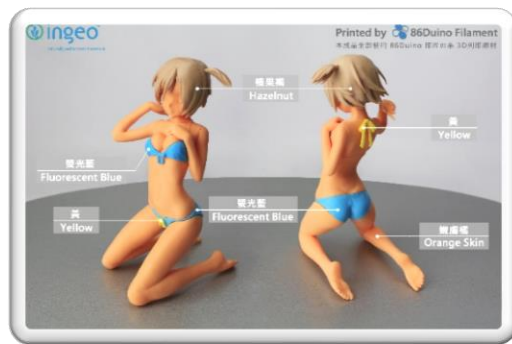
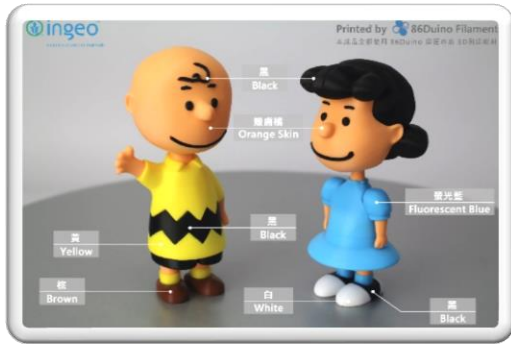







| 顏色 Color | 英文名稱 English | 訂購代號 / 1Kg Supply Code / 1 Kg | 數量 Q'ty | 訂購代號 / 500g Supply Code / 500g | 數量 Q'ty | 訂購代號 / 200g Supply Code / 200g | 數量 Q'ty |
|-------------|-------------------|----------------------------------|------------|-----------------------------------|------------|-----------------------------------|------------|
| 紅 | Red | 86Duino-Line-C0R | | | | 86Duino-Line-A0R | |
| 橙 | Orange | 86Duino-Line-CRG | | | | 86Duino-Line-ARG | |
| 黃 | Yellow | 86Duino-Line-C0Y | | | | 86Duino-Line-A0Y | |
| 螢光綠 | Fluorescent Green | 86Duino-Line-C0G | | | | 86Duino-Line-A0G | |
| 螢光藍 | Fluorescent Blue | 86Duino-Line-C0B | | | | 86Duino-Line-A0B | |
| 靛 | Indigo | 86Duino-Line-C0D | | | | 86Duino-Line-A0D | |
| 紫 | Purple | 86Duino-Line-C0P | | | | 86Duino-Line-A0P | |
| 黑 | Black | 86Duino-Line-CBK | | | | 86Duino-Line-ABK | |
| 白 | White | 86Duino-Line-C0W | | | | 86Duino-Line-A0W | |
| 粉紅 | Pink | 86Duino-Line-CPN | | | | 86Duino-Line-APN | |
| 棕 | Brown | 86Duino-Line-CBR | | | | 86Duino-Line-ABR | |
| 森林綠 | Forest Green | 86Duino-Line-CFG | | | | 86Duino-Line-AFG | |
| 透明 | Transparent | | | 86Duino-Line-B0T | | | |
| 夜光綠 | Luminous Green | | | 86Duino-Line-B0L | | 86Duino-Line-A0L | |
| 金 | Golden | | | 86Duino-Line-BGD | | 86Duino-Line-AGD | |
| 石英粉 | Rose Quartz | | | 86Duino-Line-BRQ | | 86Duino-Line-ARQ | |
| 靜謐藍 | Serenity | | | 86Duino-Line-BSR | | 86Duino-Line-ASR | |
| 蘭花紫 | Radiant Orchid | | | 86Duino-Line-BRP | | 86Duino-Line-ARP | |
| 蘋果綠 | Apple Green | | | 86Duino-Line-BAG | | 86Duino-Line-AAG | |
| 大理石 | Marble | | | 86Duino-Line-B0M | | | |
| 覆盆子 | Raspberry | | | | | | |
| 薰衣草 | Lavender | | | | | | |
| 薄荷綠 | Mint Green | | | | | | |
| 鐵金屬 | Iron | | | | | | |
| 薩克綠 | Zaku Green | | | 86Duino-Line-BZG | | | |
| 鋼彈紅 | Gundam Red | | | 86Duino-Line-BGR | | | |
| 金盞黃 | Marigolds | | | 86Duino-Line-BMY | | | |
| 台灣紅 | Taiwan Red | | | 86Duino-Line-BTR | | | |
| 湖水綠 | Green Lake | | | 86Duino-Line-BGL | | | |
| 嫩膚橘 | Orange Skin | | | 86Duino-Line-BRS | | | |
| 牛仔藍 | Denim Blue | | | 86Duino-Line-BDB | | 86Duino-Line-ADB | |
| 簡約灰 | Simple Grey | | | 86Duino-Line-BSG | | | |
| 珠貝白 | Pearl White | | | 86Duino-Line-BPW | | 86Duino-Line-APW | |
| 榛果褐 | Hazelnut | | | 86Duino-Line-BHN | | 86Duino-Line-AHN | |
| 天堂藍 | Paradise Blue | | | 86Duino-Line-BPB | | 86Duino-Line-APB | |
| 冰河銀 | Glacier Silver | | | 86Duino-Line-BGS | | 86Duino-Line-AGS | |
| 赤褐銅 | Terracotta Copper | | | 86Duino-Line-BTC | | 86Duino-Line-ATC | |
| 冰潤藍 | Ice Steam Blue | | | 86Duino-Line-BIB | | 86Duino-Line-AIB | |

Note:

1. 200g package filament length around 70 meters
2. 500g package filament length around 169 meters
3. 1.0kg package filament length around 342 meters

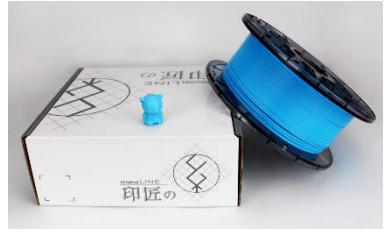
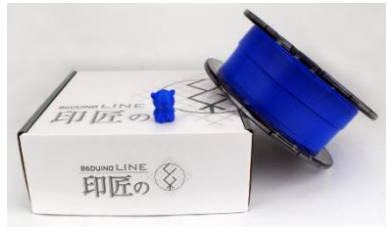
1.0 KG Package

| | | |
|----|---|---|
| C1 |  | <p>紅 Red (Supply Code : 86Duino-Line-COR) Material : NatureWorks 3D850 PLA Pantone : 032C Diameter : 1.75mm Net Weight : 1.0kg / Gross Weight : 1.35kg Length: 342 Meters Spool : 200mm (D) x 82mm (W) x 52mm (Hole) Nozzle Temp. : 195°C ~ 210°C</p> |
| C2 |  | <p>橙 Orange (Supply Code : 86Duino-Line-CRG) Material : NatureWorks 3D850 PLA Pantone: 1495C Diameter : 1.75mm Net Weight : 1.0kg / Gross Weight : 1.35kg Length: 342 Meters Spool : 200mm (D) x 82mm (W) x 52mm (Hole) Nozzle Temp. : 195°C ~ 210°C</p> |
| C3 |  | <p>黃 Yellow (Supply Code : 86Duino-Line-C0Y) Material : NatureWorks 3D850 PLA Pantone : 101C Diameter : 1.75mm Net Weight : 1.0kg / Gross Weight : 1.35kg Length: 342 Meters Spool : 200mm (D) x 82mm (W) x 52mm (Hole) Nozzle Temp. : 195°C ~ 210°C</p> |
| C4 |  | <p>螢光綠 F. Green (Supply Code : 86Duino-Line-C0G) Material : NatureWorks 3D850 PLA Pantone : 2420C Diameter : 1.75mm Net Weight : 1.0kg / Gross Weight : 1.35kg Length: 342 Meters Spool : 200mm (D) x 82mm (W) x 52mm (Hole) Nozzle Temp. : 195°C ~ 210°C</p> |
| C5 |  | <p>螢光藍 F. Blue (Supply Code : 86Duino-Line-C0B) Material : NatureWorks 3D850 PLA Pantone : 2171C Diameter : 1.75mm Net Weight : 1.0kg / Gross Weight : 1.35kg Length: 342 Meters Spool : 200mm (D) x 82mm (W) x 52mm (Hole) Nozzle Temp. : 195°C ~ 210°C</p> |
| C6 |  | <p>靛 Indigo (Supply Code : 86Duino-Line-C0D) Material : NatureWorks 3D850 PLA Pantone : 286C Diameter : 1.75mm Net Weight : 1.0kg / Gross Weight : 1.35kg Length: 342 Meters Spool : 200mm (D) x 82mm (W) x 52mm (Hole) Nozzle Temp. : 195°C ~ 210°C</p> |
| C7 |  | <p>紫 Purple (Supply Code : 86Duino-Line-C0P) Material : NatureWorks 3D850 PLA Diameter : 1.75mm Pantone : 2613C Net Weight : 1.0kg / Gross Weight : 1.35kg Length: 342 Meters Spool : 200mm (D) x 82mm (W) x 52mm (Hole) Nozzle Temp. : 195°C ~ 210°C</p> |

| | | |
|-----|---|--|
| C8 |  | <p>黒 Black (Supply Code : 86Duino-Line-CBK) Material : NatureWorks 3D850 PLA Pantone : Black Diameter : 1.75mm Net Weight : 1.0kg / Gross Weight : 1.35kg Length: 342 Meters Spool : 200mm (D) x 82mm (W) x 52mm (Hole) Nozzle Temp. : 195℃ ~ 210℃</p> |
| C9 |  | <p>白 White (Supply Code : 86Duino-Line-COW) Material : NatureWorks 3D850 PLA Pantone : White Diameter : 1.75mm Net Weight : 1.0kg / Gross Weight : 1.35kg Length: 342 Meters Spool : 200mm (D) x 82mm (W) x 52mm (Hole) Nozzle Temp. : 195℃ ~ 210℃</p> |
| C10 |  | <p>粉紅 Rose Pink (Supply Code : 86Duino-Line-CPN) Material : NatureWorks 3D850 PLA Pantone : 2045C Diameter : 1.75mm Net Weight : 1.0kg / Gross Weight : 1.35kg Length: 342 Meters Spool : 200mm (D) x 82mm (W) x 52mm (Hole) Nozzle Temp. : 195℃ ~ 210℃</p> |
| C11 |  | <p>棕 Brown (Supply Code : 86Duino-Line-CBR) Material : NatureWorks 3D850 PLA Pantone : 7568C Diameter : 1.75mm Net Weight : 1.0kg / Gross Weight : 1.35kg Length: 342 Meters Spool : 200mm (D) x 82mm (W) x 52mm (Hole) Nozzle Temp. : 195℃ ~ 210℃</p> |
| C12 |  | <p>森林緑 Forest Green (Supply Code : 86Duino-Line-CFG) Material : NatureWorks 3D850 PLA Pantone : 349CC Diameter : 1.75mm Net Weight : 1.0kg / Gross Weight : 1.35kg Length: 342 Meters Spool : 200mm (D) x 82mm (W) x 52mm (Hole) Nozzle Temp. : 195℃ ~ 210℃</p> |

500g Package

| | | |
|----|--|---|
| B1 |  | <p>透明 Transparent (Supply Code : 86Duino-Line-B0T) Material : NatureWorks 3D850 PLA Pantone : Diameter : 1.75mm Net Weight : 500g / Gross Weight : 0.75kg Length: 169 Meters Spool : 200mm (D) x 48mm (W) x 52mm (Hole) Nozzle Temp. : 195°C ~ 210°C</p> |
| B2 |  | <p>金 Golden (Supply Code : 86Duino-Line-BGD) Material : NatureWorks 3D850 PLA Pantone : 871C Diameter : 1.75mm Net Weight : 500g / Gross Weight : 0.75kg Length: 169 Meters Spool : 200mm (D) x 48mm (W) x 52mm (Hole) Nozzle Temp. : 195°C ~ 210°C</p> |
| B3 |  | <p>石英粉 Rose Quartz (Supply Code : 86Duino-Line-BRQ) Material : NatureWorks 3D850 PLA Pantone : 203C Diameter : 1.75mm Net Weight : 500g / Gross Weight : 0.75kg Length: 169 Meters Spool : 200mm (D) x 48mm (W) x 52mm (Hole) Nozzle Temp. : 195°C ~ 210°C</p> |
| B4 |  | <p>靜謐藍 Serenity (Supply Code : 86Duino-Line-BSR) Material : NatureWorks 3D850 PLA Pantone : 2128C Diameter : 1.75mm Net Weight : 500g / Gross Weight : 0.75kg Length: 169 Meters Spool : 200mm (D) x 48mm (W) x 52mm (Hole) Nozzle Temp. : 195°C ~ 210°C</p> |
| B5 |  | <p>蘭花紫 Radiant Orchid (Supply Code : 86Duino-Line-BRP) Material : NatureWorks 3D850 PLA Pantone : 2562C Diameter : 1.75mm Net Weight : 500g / Gross Weight : 0.75kg Length: 169 Meters Spool : 200mm (D) x 48mm (W) x 52mm (Hole) Nozzle Temp. : 195°C ~ 210°C</p> |
| B6 |  | <p>蘋果綠 Apple Green (Supply Code : 86Duino-Line-BAG) Material : NatureWorks 3D850 PLA Pantone : 587C Diameter : 1.75mm Net Weight : 500g / Gross Weight : 0.75kg Length: 169 Meters Spool : 200mm (D) x 48mm (W) x 52mm (Hole) Nozzle Temp. : 195°C ~ 210°C</p> |
| B7 |  <p style="text-align: center; color: red; font-weight: bold;">停產 / Phase out</p> | <p>覆盆子 Raspberry (Supply Code : 86Duino-Line-BRB) Material : NatureWorks 3D850 PLA Pantone : - Diameter : 1.75mm Net Weight : 500g Gross Weight : 0.75kg Spool : 200mm (D) x 48mm (W) x 52mm (Hole) Nozzle Temp. : 195°C ~ 210°C</p> |

| | | |
|-----|---|---|
| B8 |  <p style="text-align: center; color: red;">停產 / Phase out</p> | <p>薰衣草 Lavender (Supply Code : 86Duino-Line-BLV) Material : NatureWorks 3D850-PLA Pantone : — Diameter : 1.75mm Net Weight : 500g Gross Weight : 0.75kg Spool : 200mm (D) x 48mm (W) x 52mm (Hole) Nozzle Temp. : 195°C ~ 210°C</p> |
| B9 |  <p style="text-align: center; color: red;">停產 / Phase out</p> | <p>薄荷綠 Mint Green (Supply Code : 86Duino-Line-BMG) Material : NatureWorks 3D850-PLA Pantone : — Diameter : 1.75mm Net Weight : 500g Gross Weight : 0.75kg Spool : 200mm (D) x 48mm (W) x 52mm (Hole) Nozzle Temp. : 195°C ~ 210°C</p> |
| B10 |  | <p>薩克綠 Zaku Green (Supply Code : 86Duino-Line-BZG) Material : NatureWorks 3D850-PLA Pantone : 200C Diameter : 1.75mm Net Weight : 500g / Gross Weight : 0.75kg Length: 169 Meters Spool : 200mm (D) x 48mm (W) x 52mm (Hole) Nozzle Temp. : 195°C ~ 210°C</p> |
| B11 |  | <p>鋼彈紅 Gundam Red (Supply Code : 86Duino-Line-BGR) Material : NatureWorks 3D850-PLA Pantone : 574C Diameter : 1.75mm Net Weight : 500g / Gross Weight : 0.75kg Length: 169 Meters Spool : 200mm (D) x 48mm (W) x 52mm (Hole) Nozzle Temp. : 195°C ~ 210°C</p> |
| B12 |  | <p>金盞黃 Marigolds (Supply Code : 86Duino-Line-BMY) Material : NatureWorks 3D850-PLA Pantone : 2010C Diameter : 1.75mm Net Weight : 500g / Gross Weight : 0.75kg Length: 169 Meters Spool : 200mm (D) x 48mm (W) x 52mm (Hole) Nozzle Temp. : 195°C ~ 210°C</p> |
| B13 |  | <p>台灣紅 Taiwan Red (Supply Code : 86Duino-Line-BTR) Material : NatureWorks 3D850-PLA Pantone : 213C Diameter : 1.75mm Net Weight : 500g / Gross Weight : 0.75kg Length: 169 Meters Spool : 200mm (D) x 48mm (W) x 52mm (Hole) Nozzle Temp. : 195°C ~ 210°C</p> |
| B14 |  | <p>湖水綠 Green Lake (Supply Code : 86Duino-Line-BGL) Material : NatureWorks 3D850-PLA Pantone : 3258C Diameter : 1.75mm Net Weight : 500g / Gross Weight : 0.75kg Length: 169 Meters Spool : 200mm (D) x 48mm (W) x 52mm (Hole) Nozzle Temp. : 195°C ~ 210°C</p> |

| | | |
|-----|---|---|
| B15 |  | <p>嫩膚橘 Orange Skin (Supply Code : 86Duino-Line-BRS) Material : NatureWorks 3D850 PLA Pantone : 713C Diameter : 1.75mm Net Weight : 500g / Gross Weight : 0.75kg Length: 169 Meters Spool : 200mm (D) x 48mm (W) x 52mm (Hole) Nozzle Temp. : 195°C ~ 210°C</p> |
| B16 |  | <p>牛仔藍 Demin Blue (Supply Code : 86Duino-Line-BDB) Material : NatureWorks 3D850 PLA Pantone : 2391C Diameter : 1.75mm Net Weight : 500g / Gross Weight : 0.75kg Length: 169 Meters Spool : 200mm (D) x 48mm (W) x 52mm (Hole) Nozzle Temp. : 195°C ~ 210°C</p> |
| B17 |  | <p>簡約灰 Simple Grey (Supply Code : 86Duino-Line-BSG) Material : NatureWorks 3D850 PLA Pantone : 642C Diameter : 1.75mm Net Weight : 500g / Gross Weight : 0.75kg Length: 169 Meters Spool : 200mm (D) x 48mm (W) x 52mm (Hole) Nozzle Temp. : 195°C ~ 210°C</p> |
| B18 |  | <p>大理石 Marble (Supply Code : 86Duino-Line-B0M) Material : NatureWorks 3D850 PLA Pantone : Diameter : 1.75mm Net Weight : 500g / Gross Weight : 0.75kg Length: 169 Meters Spool : 200mm (D) x 48mm (W) x 52mm (Hole) Nozzle Temp. : 195°C ~ 210°C</p> |
| B19 |  | <p>珠貝白 Pearl White (Supply Code : 86Duino-Line-BPW) Material : NatureWorks 3D850 PLA Pantone : Diameter : 1.75mm Net Weight : 500g / Gross Weight : 0.75kg Length: 169 Meters Spool : 200mm (D) x 48mm (W) x 52mm (Hole) Nozzle Temp. : 195°C ~ 210°C</p> |
| B20 |  | <p>榛果褐 Hazlnut (Supply Code : 86Duino-Line-BHN) Material : NatureWorks 3D850 PLA Pantone : 2311C Diameter : 1.75mm Net Weight : 500g / Gross Weight : 0.75kg Length: 169 Meters Spool : 200mm (D) x 48mm (W) x 52mm (Hole) Nozzle Temp. : 195°C ~ 210°C</p> |
| B21 |  | <p>天堂藍 Paradise Blue (Supply Code : 86Duino-Line-BPB) Material : NatureWorks 3D850 PLA Pantone : 324C Diameter : 1.75mm Net Weight : 500g / Gross Weight : 0.75kg Length: 169 Meters Spool : 200mm (D) x 48mm (W) x 52mm (Hole) Nozzle Temp. : 195°C ~ 210°C</p> |

| | | |
|-----|---|--|
| B22 |  | <p>冰河銀 Glacier Silver (Supply Code : 86Duino-Line-BGS) Material : NatureWorks 3D850 PLA Pantone : 877C Diameter : 1.75mm Net Weight : 500g / Gross Weight : 0.75kg Length: 169 Meters Spool : 200mm (D) x 48mm (W) x 52mm (Hole) Nozzle Temp. : 195°C ~ 210°C</p> |
| B23 |  | <p>赤褐銅 Terracotta Copper (Supply Code : 86Duino-Line-BTC) Material : NatureWorks 3D850 PLA Pantone : 7628C Diameter : 1.75mm Net Weight : 500g / Gross Weight : 0.75kg Length: 169 Meters Spool : 200mm (D) x 48mm (W) x 52mm (Hole) Nozzle Temp. : 195°C ~ 210°C</p> |
| B24 |  | <p>冰潤藍 Ice Steam Blue (Supply Code : 86Duino-Line-BIB) Material : NatureWorks 3D850 PLA Pantone : 2975C Diameter : 1.75mm Net Weight : 500g / Gross Weight : 0.75kg Length: 169 Meters Spool : 200mm (D) x 48mm (W) x 52mm (Hole) Nozzle Temp. : 195°C ~ 210°C</p> |

200g Package

| | | |
|----|---|---|
| A1 |  <p>86DUINO LINE The Prime 3D Filament 印匠の 3D 列印線材 Ingeo 美國NatureWorks公司 授權認證 採用Ingeo原材料製作</p> | <p>紅 Red (Supply Code : 86Duino-Line-A0R) Material : NatureWorks 3D850 PLA Pantone : 032C Diameter : 1.75mm Net Weight : 200g / Gross Weight : 330g Length: 70 Meters Spool : 130mm (D) x 48mm (W) x 52mm (Hole) Nozzle Temp. : 195°C ~ 210°C</p> |
| A2 |  <p>86DUINO LINE The Prime 3D Filament 印匠の 3D 列印線材 Ingeo 美國NatureWorks公司 授權認證 採用Ingeo原材料製作</p> | <p>橙 Orange (Supply Code : 86Duino-Line-ARG) Material : NatureWorks 3D850 PLA Pantone : 1495C Diameter : 1.75mm Net Weight : 200g / Gross Weight : 330g Length: 70 Meters Spool : 130mm (D) x 48mm (W) x 52mm (Hole) Nozzle Temp. : 195°C ~ 210°C</p> |
| A3 |  <p>86DUINO LINE The Prime 3D Filament 印匠の 3D 列印線材 Ingeo 美國NatureWorks公司 授權認證 採用Ingeo原材料製作</p> | <p>黃 Yellow (Supply Code : 86Duino-Line-A0Y) Material : NatureWorks 3D850 PLA Pantone : 101C Diameter : 1.75mm Net Weight : 200g / Gross Weight : 330g Length: 70 Meters Spool : 130mm (D) x 48mm (W) x 52mm (Hole) Nozzle Temp. : 195°C ~ 210°C</p> |
| A4 |  <p>86DUINO LINE The Prime 3D Filament 印匠の 3D 列印線材 Ingeo 美國NatureWorks公司 授權認證 採用Ingeo原材料製作</p> | <p>螢光綠 F. Green (Supply Code : 86Duino-Line-A0G) Material : NatureWorks 3D850 PLA Pantone : 2420C Diameter : 1.75mm Net Weight : 200g / Gross Weight : 330g Length: 70 Meters Spool : 130mm (D) x 48mm (W) x 52mm (Hole) Nozzle Temp. : 195°C ~ 210°C</p> |
| A5 |  <p>86DUINO LINE The Prime 3D Filament 印匠の 3D 列印線材 Ingeo 美國NatureWorks公司 授權認證 採用Ingeo原材料製作</p> | <p>螢光藍 F. Blue (Supply Code : 86Duino-Line-A0B) Material : NatureWorks 3D850 PLA Pantone : 2171C Diameter : 1.75mm Net Weight : 200g / Gross Weight : 330g Length: 70 Meters Spool : 130mm (D) x 48mm (W) x 52mm (Hole) Nozzle Temp. : 195°C ~ 210°C</p> |
| A6 |  <p>86DUINO LINE The Prime 3D Filament 印匠の 3D 列印線材 Ingeo 美國NatureWorks公司 授權認證 採用Ingeo原材料製作</p> | <p>靛 Indigo (Supply Code : 86Duino-Line-A0D) Material : NatureWorks 3D850 PLA Pantone : 286C Diameter : 1.75mm Net Weight : 200g / Gross Weight : 330g Length: 70 Meters Spool : 130mm (D) x 48mm (W) x 52mm (Hole) Nozzle Temp. : 195°C ~ 210°C</p> |
| A7 |  <p>86DUINO LINE The Prime 3D Filament 印匠の 3D 列印線材 Ingeo 美國NatureWorks公司 授權認證 採用Ingeo原材料製作</p> | <p>紫 Purple (Supply Code : 86Duino-Line-A0P) Material : NatureWorks 3D850 PLA Pantone : 2613C Diameter : 1.75mm Net Weight : 200g / Gross Weight : 330g Length: 70 Meters Spool : 130mm (D) x 48mm (W) x 52mm (Hole) Nozzle Temp. : 195°C ~ 210°C</p> |

| | | |
|-----|---|--|
| A8 |  | <p>黑 Black (Supply Code : 86Duino-Line-ABK) Material : NatureWorks 3D850 PLA Pantone : Black Diameter : 1.75mm Net Weight : 200g / Gross Weight : 330g Length: 70 Meters Spool : 130mm (D) x 48mm (W) x 52mm (Hole) Nozzle Temp. : 195°C ~ 210°C</p> |
| A9 |  | <p>粉紅 Pink (Supply Code : 86Duino-Line-APN) Material : NatureWorks 3D850 PLA Pantone : 2045C Diameter : 1.75mm Net Weight : 200g / Gross Weight : 330g Length: 70 Meters Spool : 130mm (D) x 48mm (W) x 52mm (Hole) Nozzle Temp. : 195°C ~ 210°C</p> |
| A10 |  | <p>金 Golden (Supply Code : 86Duino-Line-AGD) Material : NatureWorks 3D850 PLA Pantone : 871C Diameter : 1.75mm Net Weight : 200g / Gross Weight : 330g Length: 70 Meters Spool : 130mm (D) x 48mm (W) x 52mm (Hole) Nozzle Temp. : 195°C ~ 210°C</p> |
| A11 |  | <p>棕 Brown (Supply Code : 86Duino-Line-ABR) Material : NatureWorks 3D850 PLA Pantone : 7568C Diameter : 1.75mm Net Weight : 200g / Gross Weight : 330g Length: 70 Meters Spool : 130mm (D) x 48mm (W) x 52mm (Hole) Nozzle Temp. : 195°C ~ 210°C</p> |
| A12 |  | <p>靜謐藍 Serenity (Supply Code : 86Duino-Line-ASR) Material : NatureWorks 3D850 PLA Pantone : 2128C Diameter : 1.75mm Net Weight : 200g / Gross Weight : 330g Length: 70 Meters Spool : 130mm (D) x 48mm (W) x 52mm (Hole) Nozzle Temp. : 195°C ~ 210°C</p> |
| A13 |  | <p>石英粉 Rose Quartz (Supply Code : 86Duino-Line-ARQ) Material : NatureWorks 3D850 PLA Pantone : 2562C Diameter : 1.75mm Net Weight : 200g / Gross Weight : 330g Length: 70 Meters Spool : 130mm (D) x 48mm (W) x 52mm (Hole) Nozzle Temp. : 195°C ~ 210°C</p> |
| A14 |  | <p>蘋果綠 Apple Green (Supply Code : 86Duino-Line-AAG) Material : NatureWorks 3D850 PLA Pantone : 587C Diameter : 1.75mm Net Weight : 200g / Gross Weight : 330g Length: 70 Meters Spool : 130mm (D) x 48mm (W) x 52mm (Hole) Nozzle Temp. : 195°C ~ 210°C</p> |

| | | |
|-----|---|--|
| A15 |  | <p>珠貝白 Pearl White (Supply Code : 86Duino-Line-APW) Material : NatureWorks 3D850 PLA Pantone : Diameter : 1.75mm Net Weight : 200g / Gross Weight : 330g Length: 70 Meters Spool : 130mm (D) x 48mm (W) x 52mm (Hole) Nozzle Temp. : 195°C ~ 210°C</p> |
| A16 |  | <p>榛果褐 Hazlnut (Supply Code : 86Duino-Line-BHN) Material : NatureWorks 3D850 PLA Pantone : 2311C Diameter : 1.75mm Net Weight : 200g / Gross Weight : 330g Length: 70 Meters Spool : 130mm (D) x 48mm (W) x 52mm (Hole) Nozzle Temp. : 195°C ~ 210°C</p> |
| A17 |  | <p>天堂藍 Paradise Blue (Supply Code : 86Duino-Line-APB) Material : NatureWorks 3D850 PLA Pantone : 324C Diameter : 1.75mm Net Weight : 200g / Gross Weight : 330g Length: 70 Meters Spool : 130mm (D) x 48mm (W) x 52mm (Hole) Nozzle Temp. : 195°C ~ 210°C</p> |
| A18 |  | <p>夜光綠 Luminous Green (Supply Code : 86Duino-Line-AOL) Material : NatureWorks 3D850 PLA Pantone : Diameter : 1.75mm Net Weight : 200g / Gross Weight : 330g Length: 70 Meters Spool : 130mm (D) x 48mm (W) x 52mm (Hole) Nozzle Temp. : 195°C ~ 210°C</p> |
| A19 |  | <p>牛仔藍 Demin Blue (Supply Code : 86Duino-Line-ADB) Material : NatureWorks 3D850 PLA Pantone : Diameter : 1.75mm Net Weight : 200g / Gross Weight : 330g Length: 70 Meters Spool : 130mm (D) x 48mm (W) x 52mm (Hole) Nozzle Temp. : 195°C ~ 210°C</p> |
| A20 |  | <p>冰河銀 Glacier Silver (Supply Code : 86Duino-Line-AGS) Material : NatureWorks 3D850 PLA Pantone : 877C Diameter : 1.75mm Net Weight : 200g / Gross Weight : 330g Length: 70 Meters Spool : 130mm (D) x 48mm (W) x 52mm (Hole) Nozzle Temp. : 195°C ~ 210°C</p> |
| A21 |  | <p>赤褐銅 Terracotta Copper (Supply Code : 86Duino-Line-ATC) Material : NatureWorks 3D850 PLA Pantone : 7628C Diameter : 1.75mm Net Weight : 200g / Gross Weight : 330g Length: 70 Meters Spool : 130mm (D) x 48mm (W) x 52mm (Hole) Nozzle Temp. : 195°C ~ 210°C</p> |

| | | |
|-----|---|---|
| A22 |  | <p>森林綠 Forest Green (Supply Code : 86Duino-Line-AFG) Material : NatureWorks 3D850 PLA Pantone : 349C Diameter : 1.75mm Net Weight : 200g / Gross Weight : 330g Length: 70 Meters Spool : 130mm (D) x 48mm (W) x 52mm (Hole) Nozzle Temp. : 195°C ~ 210°C</p> |
| A22 |  | <p>冰潤藍 Ice Steam Blue (Supply Code : 86Duino-Line-AIB) Material : NatureWorks 3D850 PLA Pantone : 2975C Diameter : 1.75mm Net Weight : 200g / Gross Weight : 330g Length: 70 Meters Spool : 130mm (D) x 48mm (W) x 52mm (Hole) Nozzle Temp. : 195°C ~ 210°C</p> |

NatureWorks Ingeo 3D850 PLA Filament

Ingeo 3D850 PLA Formulation for 3D Filament Offers Heat and Impact Resistance Rivaling ABS and Processes and Prints with the Ease of PLA

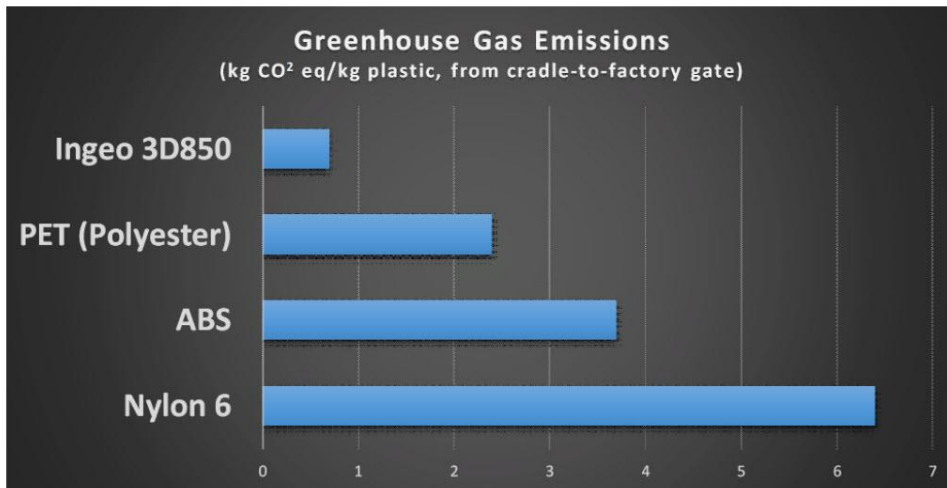

HEAT RESISTANCE

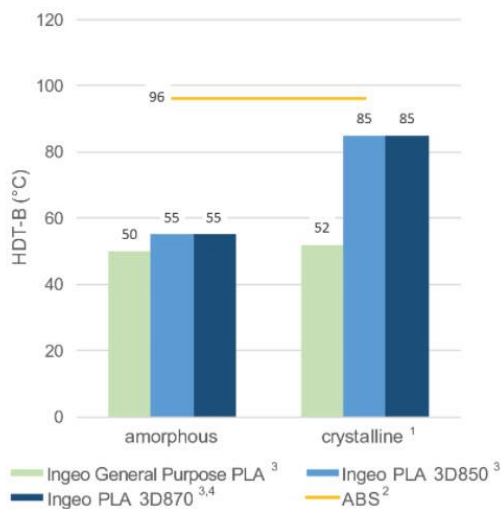

IMPACT STRENGTH

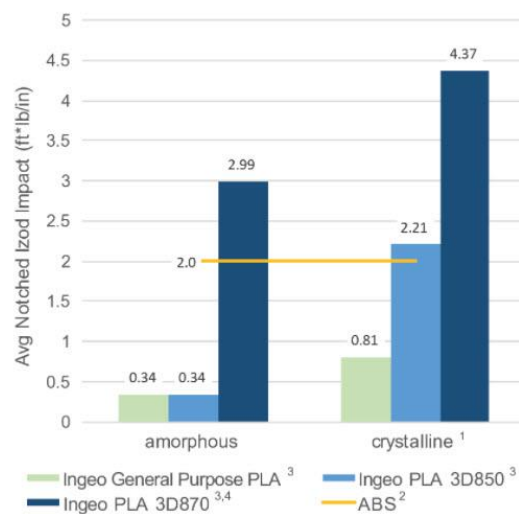

1. Annealed for 10-20 min @ 110-120°C

2. Values from literature.

3. All test bars were 3D printed at 100% infill. For more on orientations of printed parts, see the Ingeo 3D870 technical data sheet on www.natureworkslc.com.

4. 3D870 was tested by Essentium Materials.



1.0 KG Spool Dimension

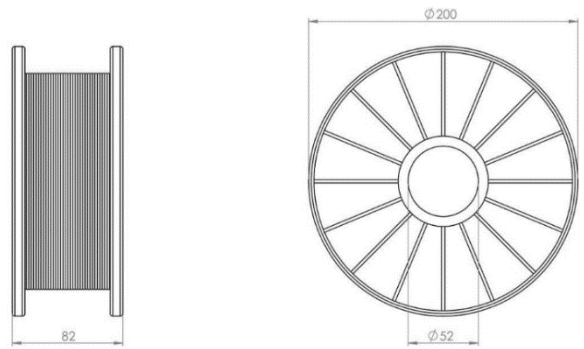

500g Spool Dimension

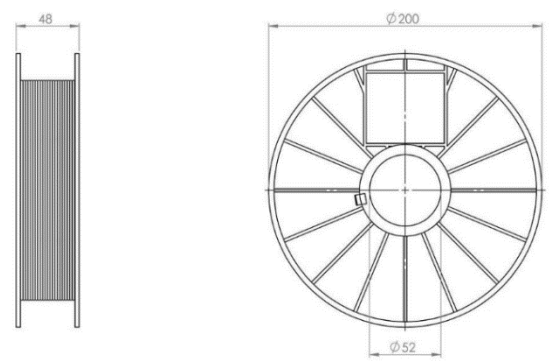

200g Spool Dimension

