

FEATURES

- PC/104 Plus 96 bit (or 48 bit) TTL-CMOS high speed digital I/O
- Change of State detection = Low CPU overhead
- Software selectable in / out as 8 bit and 4 bit ports
- I/O lines provide 32mA source, 64mA sink current
- I/O buffers enabled or tri-stated under SW control
- I/O pulled up to 5V for contact monitoring
- Resettable fused 5V outputs at 50-pin connectors
- Compatible with Industry-Standard I/O Racks such as Gordos, OPTO22, Potter & Brumfield, etc.
- Emulates 4 industry standard 8255 PPIS (mode 0)
- Full 32-bit PCI interface design, 33MHz clock
- Known power-up states
- Output port status read back
- Standard 50-pin IDC connectors (x4)

FACTORY OPTIONS

- Extended operating temperature -40 to +85°C
- PCI-104 (no ISA connector)
- RoHS compliance

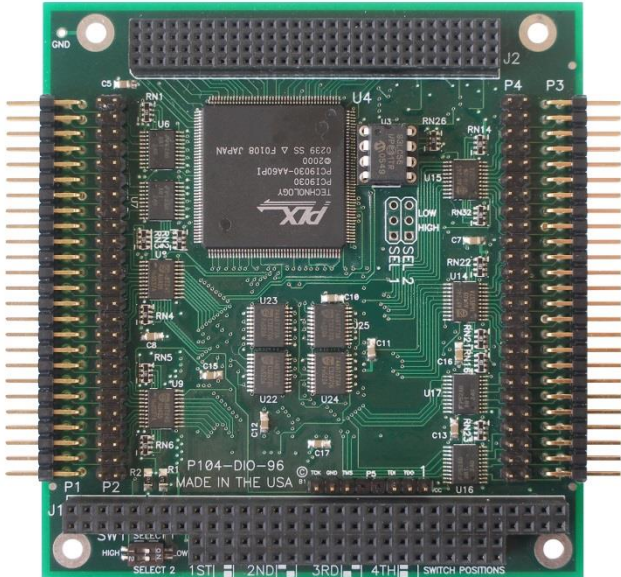

FUNCTIONAL DESCRIPTION

This PC104 plus board features 96 bits of TTL-compatible digital I/O with high-current capabilities. Each digital port can be programmed to accept inputs or to drive outputs. The I/O wiring connections are via industry standard 50-pin connectors. For external circuits, fused 5VDC power is available at pin 49 of each I/O connector. The resettable fuse is rated at 0.5A.





All I/O lines are buffered by a type ABT family tristate transceiver capable of sourcing 32mA or sinking 64mA per pin. The buffers are configured under program control for input or output. Pull-up (10k ohm) resistors are useful for contact monitoring and assure that there are no erroneous outputs at power-up until the card is initialized by software.

VERSIONS

The P104-DIO-96 has 96 digital I/O lines, 16 of which (4 per group) have change-of-state detection capabilities for reduced CPU overhead and timing critical and process control applications. For less-dense or non-timing critical applications, specify our P104-DIO-48.

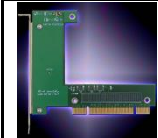
The P104-DIO-48S has 48 digital I/O lines, each of which has change-of-state detection.

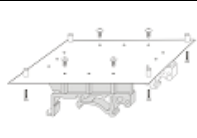
ACCESSORIES

PCI-P104-ADAP	IIB-24	STB-96CH or STB-48CH	MP104-DIN	STB-50	DIN-SNAP-6
Develop & test software and hardware in a desktop PCI slot	Converts 24 TTL inputs into optically-isolated inputs	50-Pin Multi-Header Universal Screw Terminal Board for 96 or 48 I/O Channels w/T-BOX enclosure	Mounting adapter plate for affixing STB-96CH or STB-48CH to a DIN-rail	Screw terminal board, ships with standoffs but can also mount on SNAP-TRACK or DIN-SNAP	SNAP-TRACK for DIN-rail mounting one STB-50
					

SOFTWARE

This board is supported for use in most operating systems and includes a free Linux and Windows 2000/XP/2003 compatible software package. This package contains sample programs and source code in Visual Basic, Delphi and Visual C++ for Windows. Also incorporated is a graphical setup program in Windows. Third party support includes a Windows standard DLL interface usable from the most popular application programs and includes example LabView VIs. Embedded OS support includes Windows XPe.

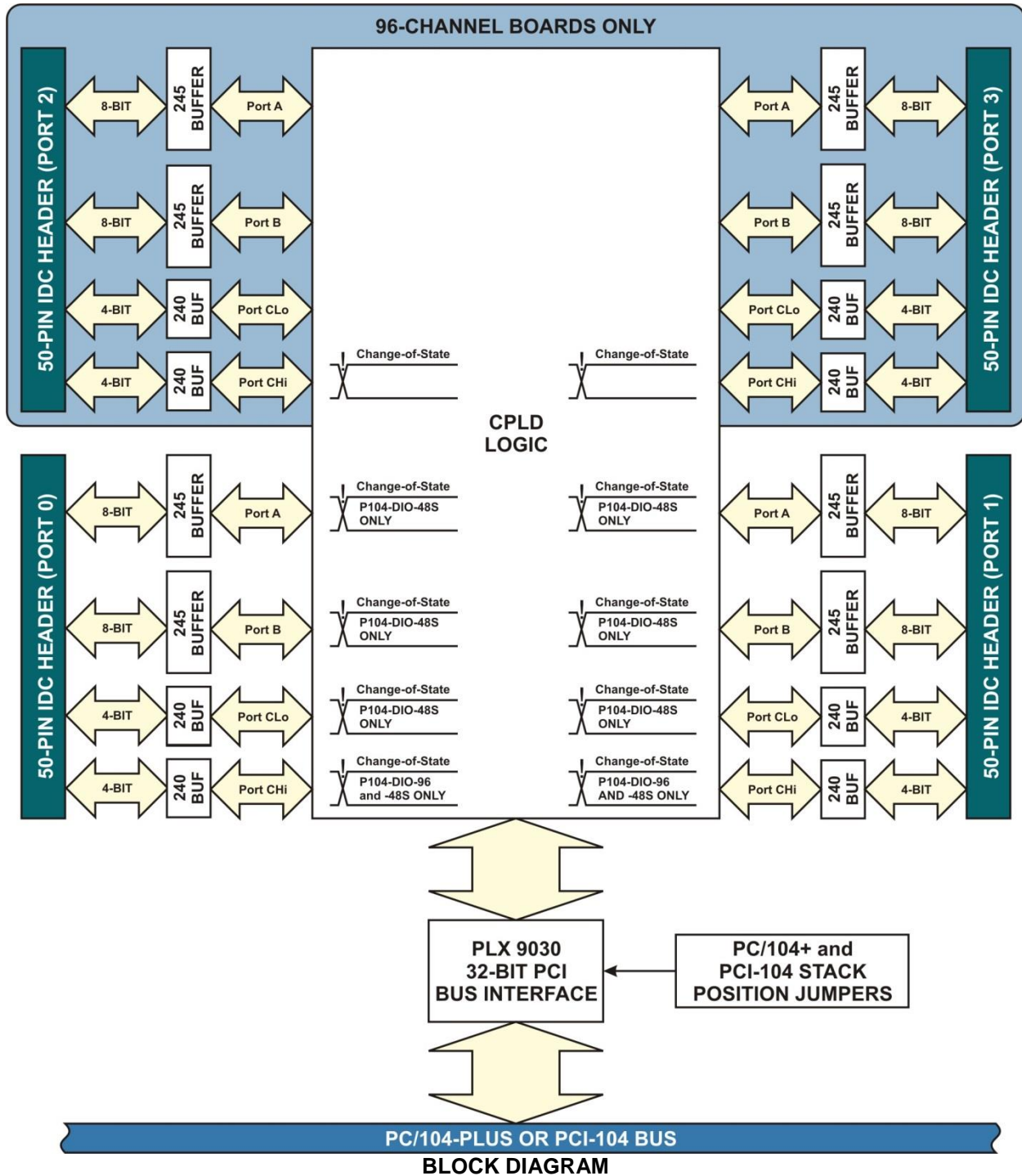

SPECIFICATIONS

Digital Inputs (TTL and CMOS Compatible)

- Logic High/Low: 2.0 to 5.0 VDC / -0.5 to +0.8 VDC
- Input Load (High): 10uA

Digital Outputs (TTL and CMOS)

- Logic High/Low: 2.5 VDC min., source 32 mA / 0.5 VDC max., sink 64 mA

Environmental

- Operating/Storage: 0°C to +70°C / -50°C to +120°C
- Humidity: 5 to 95% RH, non-condensing
- Power Output: +5 VDC from bus (resettable 0.5A fuse) on each connector

Power Required

- 3.3V quiescent current for the '96, '48S, and '48 = 10mA
- 3.3V typical current for the '96 = 50mA
- 3.3V typical current for the '48S and '48 = 30mA
- 5V typical current with all outputs low for the '96 = 352mA
- 5V typical current with all outputs low for the '48s and '48 = 176mA
- 5V typical current with all outputs high for the '96, '48S, and '48 = < 50uA

- 5V typical current with all I/O set as inputs for the '96, '48S, and '48 = < 250uA

ORDERING GUIDE

P104-DIO-96	96 High-Speed Digital I/O's, 16 with Change-of-State
P104-DIO-48S	48 High-Speed Digital I/O's, each with COS
P104-DIO-48	48 High-Speed Digital I/O bits

Model Options

- -RoHS Compliant board
- -T Extended operating temperature -40°C to +85°C

Accessories

STB-50	Screw terminal board
IIB-24	24-channel optical isolator board
CAB50F-6	6' flat ribbon cable female 50-pin connector
CAB50-6	6' flat ribbon cable female to edge connector
MP104-DIN	DIN rail mounting provision



Authorized Distributor

www.wdlsystems.com

sales@wdlsystems.com

800-548-2319

919-545-2500

220 Chatham Business Drive
Pittsboro, NC 27312